

## CHEBYSHEV MODEL AND SYNCHRONIZED SWEPT SINE METHOD IN NONLINEAR AUDIO EFFECT MODELING

*Antonin Novak, \**

Laboratoire d'Acoustique  
l'Université du Maine  
UMR CNRS 6613  
Le Mans, France  
ant.novak@gmail.com

*Laurent Simon*

Laboratoire d'Acoustique  
l'Université du Maine  
UMR CNRS 6613  
Le Mans, France  
laurent.simon@univ-lemans.fr

*Pierrick Lotton*

Laboratoire d'Acoustique  
l'Université du Maine  
UMR CNRS 6613  
Le Mans, France  
pierrick.lotton@univ-lemans.fr

*Joël Gilbert*

Laboratoire d'Acoustique  
l'Université du Maine  
UMR CNRS 6613  
Le Mans, France  
joel.gilbert@univ-lemans.fr

### ABSTRACT

A new method for the identification of nonlinear systems, based on an input exponential swept sine signal has been proposed by Farina ten years ago. This method has been recently modified in purpose of nonlinear model estimation using a synchronized swept sine signal. It allows a robust and fast one-path analysis and identification of the unknown nonlinear system under test.

In this paper this modified method is applied with Chebyshev polynomial decomposition. The combination of the Synchronized Swept Sine Method and Chebyshev polynomials leads to a nonlinear model consisting of several parallel branches, each branch containing a nonlinear Chebyshev polynomial following by a linear filter. The method is tested on an overdrive effect pedal to simulate an analog nonlinear effect in digital domain.

### 1. INTRODUCTION

Various classical analog audio effects such as compression, harmonic excitation, overdrive or distortion for guitars fall into the category of nonlinear effects. Digital emulations of such effects can be obtained when using suitable nonlinear model. Such nonlinear models are available in the literature: for example, Volterra model [1], neural network model [2], MISO model [3], NARMAX model [4], hybrid genetic algorithm [5], extended Kalman filtering [6], particle filtering [7].

All these models involve parameters or kernels that have to be estimated. If a theoretical model of the nonlinear system (NLS) under test is available, the global nonlinear behavior of the system is known and the method to be carried out consists in the estimation of the unknown parameters of the NLS. If no prior knowledge of the NLS is available, an identification procedure has to be involved. This procedure is based on the analysis of the signal produced at the output of the system under test when exciting

the system by a given and controlled input signal. Different input signals can be used, depending on the method chosen for the estimation, such as sine wave excitation, multitone excitation [8], random noise excitation [3], pseudorandom signals [9].

A new method for identification of nonlinear systems, based on the nonlinear convolution method, has been presented by Farina [10, 11]. This method uses an exponential swept sine excitation as input signal. The output signal is convolved with so called inverse filter (time-reversed replica of the excitation signal with amplitude modulation). That allows to analyze the nonlinear system in terms of higher order frequency responses that are equivalent to frequency responses of higher harmonics.

This nonlinear convolution method exhibits very good robustness and accuracy in nonlinear systems analysis, but does not allow the whole identification of a nonlinear system, nor the estimation of a nonlinear model due to the non-synchronization of the excitation signal.

The method has then been modified [12] through the synchronization of the excitation swept sine signal (Fig. 1). The mathematical background of the method is described in detail in [12] and briefly recalled in section 2. We call this modified method the *Synchronized Swept-Sine Method*.

The Synchronized Swept-Sine Method method has been already used to identify nonlinear systems under test and to estimate their nonlinear models either by polynomial series [12] that makes the model identical with a generalized Hammerstein model, or by any arbitrary nonlinear series [13]. In both cases, the nonlinear model is made up of several parallel branches, each branch containing a nonlinear function followed by a linear filter. These linear filters has been derived using a linear transformation from the higher order frequency responses (the result of the nonlinear convolution method).

In this paper, we present a different point of view on the nonlinear model. Instead of being transformed, the higher order frequency responses are used directly in the nonlinear model in which the input signal is transformed using the Chebyshev polynomials of

\* This work was supported by the French region *Pays de la Loire* under MAGIC project.

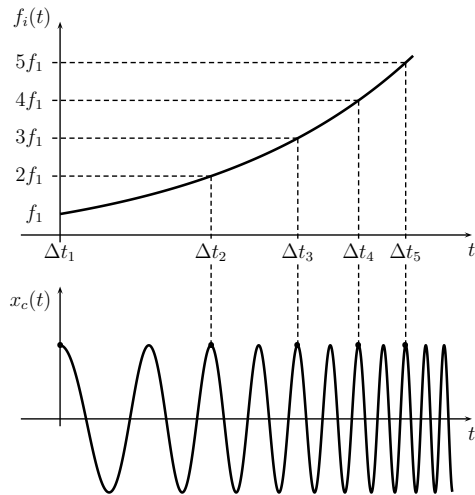

Figure 1: Synchronized swept-sine signal  $x_c(t)$  in time domain (below), and its associated instantaneous frequency  $f_i(t)$  (above).

first kind.

The paper is organized as follows. The Synchronized Swept Sine Method is briefly described in Section 2. In Section 3, a new approach in modeling nonlinear systems using Chebyshev polynomials in combination with results of the Synchronized Swept Sine Method is described. In Section 4, a real audio effect (overdrive effect pedal) is studied to show the efficiency of the method.

## 2. ANALYSIS OF NONLINEAR SYSTEMS

The input signal used for identification is an exponential swept sine signal, also called exponential chirp, defined as

$$x_c(t) = \cos \left\{ 2\pi L \left[ \exp \left( \frac{t}{L} \right) - 1 \right] \right\}, \quad (1)$$

where

$$L = \frac{1}{f_1} \text{Round} \left( \frac{\hat{T} f_1}{\ln \left( \frac{f_2}{f_1} \right)} \right), \quad (2)$$

$f_1$  and  $f_2$  being start and stop frequencies and  $\hat{T}$  the time duration of the swept-sine signal and Round represents rounding towards nearest integer. The rounding operating allows the synchronization of the excitation signal, depicted in Fig.1. This excitation signal is a strictly monotonic swept sine signal, also called asymptotic signal [14, 15], whose instantaneous frequency  $f_i(t)$  and the group delay  $t_f(t)$  may be regarded as inverse of each other

$$f_i(t) = f_1 \exp \left( \frac{t_f}{L} \right), \quad (3)$$

where  $t_f(t) \equiv t_f \equiv t$  [15, 12].

The identification of a nonlinear system consists of following steps. First, the response  $y(t)$  of the nonlinear system under test to the excitation signal is acquired. Next, the nonlinear impulse

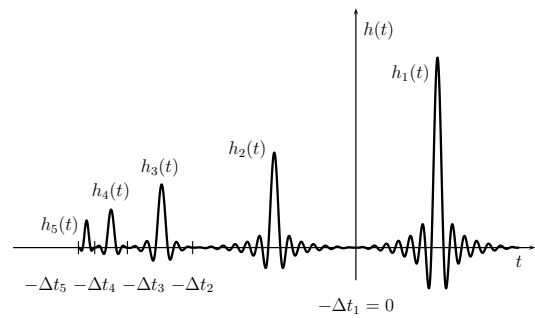

Figure 2: Nonlinear impulse response consisting of several separated impulse responses  $h_n(t)$ .

response is derived. This nonlinear impulse response is defined as

$$h(t) = IFT \left\{ \frac{Y(f)}{X_c(f)} \right\}, \quad (4)$$

where  $X_c(f)$  is the Fourier Transform (FT) of the excitation signal  $x_c(t)$ , written using the the property of asymptotic signal [16] as

$$X_c(f) = \sqrt{\frac{L}{f}} \exp \left\{ j \left[ 2\pi L \left( f - f_1 - f \ln \frac{f}{f_1} \right) + \frac{\pi}{4} \right] \right\}, \quad (5)$$

$Y(f)$  is the FT of output signal  $y(t)$  and where IFT is the inverse Fourier Transform. The nonlinear impulse response consists of several separated impulse responses  $h_n(t)$  (Fig. 2). The FT  $H_n(f)$  of each response  $h_n(t)$ ,

$$H_n(f) = FT \{ h_n(t) \}, \quad (6)$$

represents the higher order frequency response, equivalent to the frequency response of the  $n$ -th higher harmonic. These responses  $H_n(f)$  are directly used in the Chebyshev nonlinear model described in the next section.

## 3. CHEBYSHEV NONLINEAR MODEL

In this section, we introduce the nonlinear model based on Chebyshev polynomials. We use the expression *Chebyshev polynomial*

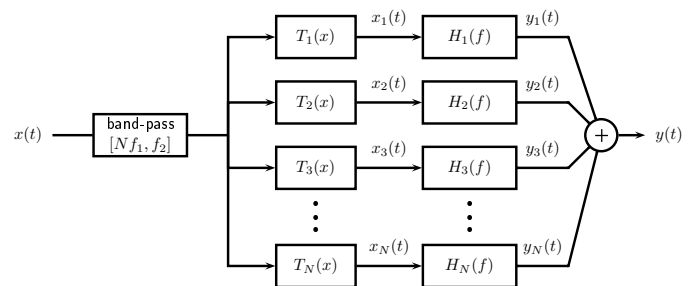

Figure 3: Nonlinear model with Chebyshev polynomials  $T_n(x)$  and higher order frequency responses (linear filters)  $H_n(f)$ ,  $n \in [1, N]$ .

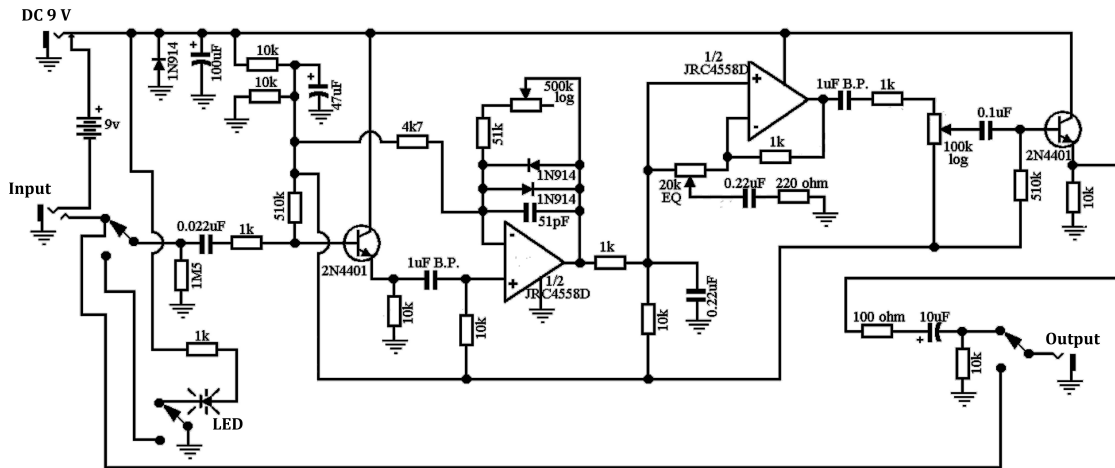

Figure 4: Schema of the modeled nonlinear analog device (overdrive effect pedal).

referring exclusively to the Chebyshev polynomial  $T_n(x)$  of the first kind defined as [17]

$$T_n(x) = \cos(n\theta), \quad \text{where } x = \cos(\theta), \quad (7)$$

and forming a sequence of orthogonal polynomials defined by the recurrence relation

$$T_n(x) = 2xT_{n-1}(x) - T_{n-2}(x), \quad n = 2, 3, \dots, \quad (8)$$

with the initial conditions

$$T_1(x) = 1, \quad T_2(x) = x. \quad (9)$$

Thanks to the property defined in Eq. (7), the Chebyshev polynomials  $T_n(x)$  represent a generator producing pure  $n$ -th higher harmonics when excited with a signal  $\cos(\omega t)$ . When excited with the synchronized swept sine signal  $x_c(t)$  defined in Eq. (1), the Chebyshev polynomial  $T_n(x_c(t))$  generates the copy of the excitation signal  $x_c(t)$  with the instantaneous frequency  $n$ -times higher than the original one.

Fig. 3 illustrates the schema of the nonlinear model used for identification of nonlinear systems. This model uses the higher order frequency responses  $H_n(f)$  obtained as linear filters and Chebyshev polynomials  $T_n(x)$  as zero memory nonlinear systems. This model exhibits structure similar to the generalized Hammerstein model, with Taylor serie replaced by the Chebyshev one. The parallel branches are preceded by a linear band-pass filter corresponding to the band in which the identification has to be made.

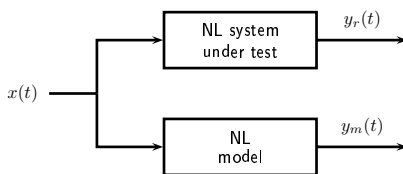
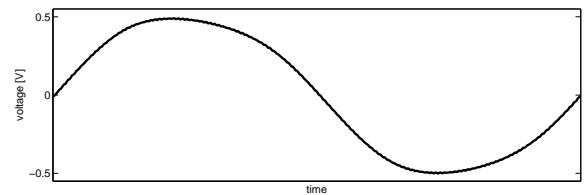
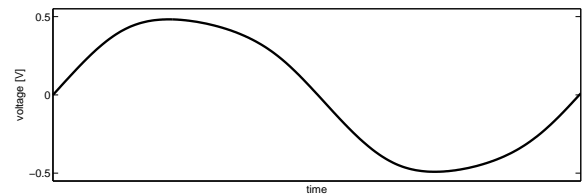

Figure 5: Block diagram of the nonlinear model validation.



(a)



(b)

Figure 6: Comparison between (a) the real overdrive effect pedal output and (b) the model output, for sine wave excitation with  $f_0 = 500$  Hz and  $A_0 = 1$  V.

#### 4. NONLINEAR AUDIO EFFECT MODELING

To test this nonlinear identification method, we choose a nonlinear analog device (overdrive effect pedal), the electronic schema of which is depicted in Fig. 4. The setting parameters of the overdrive pedal have been chosen to create a soft nonlinear effect corresponding to the real condition in which the pedal is used.

The experimental measurement consists of two steps: (a) analysis of the nonlinear system under test including the Chebyshev model identification as described in previous section and (b) comparison of the output signals of the model and of the nonlinear system under test when excited with the same signal, in order to validate the estimated model.

For the first step, the measurement conditions are selected as follows: The sampling frequency used for the experiment is

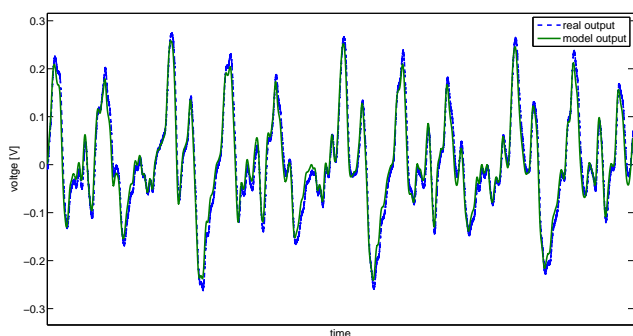

Figure 7: Sample of a music signal from an acoustic guitar: comparison between real-output and model-output.

$f_s = 192$  kHz. The excitation signal  $x_c(t)$  is sweeping from  $f_1 = 1$  Hz to  $f_2 = 10$  kHz with amplitude  $A = 1$  V. The Chebyshev nonlinear model of the system under test is then estimated for a chosen order  $N = 9$  with respect to maximum frequency  $N f_2$  less than half the sampling frequency in order to avoid any nonlinear aliasing.

The second step is the validation of the model. To validate its accuracy the following test is performed. An input signal  $x(t)$  is provided to the inputs of both real analog effect device and its estimated model, and the responses are compared. The block diagram is depicted in Fig.5. Firstly,  $x(t)$  is a sine-wave input signal with frequency  $f_0 = 500$  Hz and amplitude  $A_0 = 1$  V. Secondly, the input signal is a real music signal from an acoustic guitar. Both regenerated and real-world system outputs are then compared in time and frequency domain. We define also an error signal criterion, the mean-squared error MSE (mean value of the squared difference between original output  $y_r(t)$  and the model output  $y_m(t)$ ).

In Fig. 6, the responses to a harmonic signal ( $f_0 = 500$  Hz and  $A_0 = 1$  V) of the real overdrive effect pedal (above) and of the Chebyshev model (below) are compared. The mean squared error between both is  $MSE = 4 \cdot 10^{-5}$  V. The same test is provided for the real music signal from an acoustic guitar. Samples of both signals are depicted in Fig. 7. The mean squared error between both is  $MSE = 2 \cdot 10^{-4}$  V. Very good agreement has been obtained for both reconstructed signals, the sine wave signal and the real musical signal from an acoustic guitar.

## 5. CONCLUSIONS

In this paper a recently developed method for identification of nonlinear systems has been used with Chebyshev polynomials of first kind to model a nonlinear audio effect an overdrive effect pedal. The method for analysis and modeling nonlinear systems is based on synchronized swept sine signal and allows to identify the nonlinear system in a one-path measurement. This method allows then to model audio devices as a set of frequency responses  $H_i(f)$ . Works are now in progress to perceptually evaluate the weight and the significance of each frequency response.

## 6. ACKNOWLEDGMENTS

This work was supported by the French region *Pays de la Loire* under MAGIC project.

## 7. REFERENCES

- [1] M. Schetzen, *The Volterra and Wiener theories of nonlinear systems*, John Wiley & Sons, New York, 1980.
- [2] O. Nelles, *Nonlinear System Identification: From Classical Approaches to Neural Networks and Fuzzy Models*, Springer, Berlin, 2001.
- [3] J.S. Bendat, *Nonlinear System Techniques and Applications*, John Wiley & Sons, New York, USA, 1998.
- [4] F. Thouverez and L. Jezequel, "Identification of NARMAX models on a modal base," *J. Sound. Vib.*, vol. 189, no. 2, pp. 193–213, 1996.
- [5] Yen-Wei Chen, S. Narieda, and K. Yamashita, "Blind Non-linear System Identification Based on a Constrained Hybrid Genetic Algorithm," *IEEE Trans. Instrum. Meas.*, vol. 52, no. 3, pp. 898–902, 2003.
- [6] H.W. Sorenson, *Kalman Filtering: Theory and Application*, IEEE Press, Montvale, NJ, 1985.
- [7] O. Cappe, S.J. Godsill, and E. Moulines, "An overview of existing methods and recent advances in sequential Monte Carlo," *IEEE Proc. Signal Proc.*, vol. 95, no. 5, pp. 899–924, 2007.
- [8] P. Crama and J. Schoukens, "Initial Estimates of Wiener and Hammerstein Systems Using Multisine Excitation," *IEEE Trans. Instrum. Meas.*, vol. 50, no. 6, pp. 1791–1795, 2001.
- [9] Ai Hui Tan and K.R. Godfrey, "The generation of binary and near-binary pseudorandom signals: an overview," *IEEE Trans. Instrum. Meas.*, vol. 51, no. 4, pp. 583–588, 2002.
- [10] A. Farina, A. Bellini, and E. Armelloni, "Non-Linear Convolution: A New Approach for the Auralization of Distorting Systems," in *AES 110th convention*, Amsterdam, may 2001.
- [11] A. Farina, "Simultaneous Measurement of Impulse Response and Distortion with a Swept-Sine Technique," in *AES 108th convention*, Paris, Feb. 2000.
- [12] A. Novak, L. Simon, Kadlec F., and P Lotton, "Nonlinear System Identification Using Exponential Swept-Sine Signal," *IEEE T. Instrum. Meas.*, To be published (First Published : 2009-10-29).
- [13] A. Novak, L. Simon, Kadlec F., and P Lotton, "Modeling of Nonlinear Audio Systems using Swept-Sine signals: Application to audio effects," in *Proc. of the 12th Int. Conference on Digital Audio Effects (DAFx-09)*, Como, Italy, September 1-4, 2009.
- [14] L. Cohen, *Time-Frequency Analysis*, Englewood Cliffs, NJ, Prentice-Hall, 1995.
- [15] P. Flandrin, *Time-frequency/time-scale analysis*, vol. 10 of *Wavelet Analysis and its Applications*, Academic Press Inc., San Diego, CA, 1999.
- [16] L. Cohen, "Instantaneous frequency and group delay of a filtered signal," *Journal of the Franklin Institute*, vol. 337, no. 4, pp. 329–346, 2000.
- [17] J.C. Mason, *Chebyshev polynomials*, CRC Pr I Llc, 2003.